

# PRELIMINARY PLAT OF CHURCH HILL NORTH SUBDIVISION

## SUBDIVISION CERTIFICATE

The subdivision of land shown hereon, designated "Church Hill North Subdivision" is with the free consent and in accordance with the desires of the undersigned owners thereof. There are no Deeds of Trust or Mortgages on this property. All streets, alleys and easements are of the width and extent shown hereon and are dedicated to the City of Richmond, Virginia free and unrestricted by any previous agreements or easements, except as noted on this plat at the time of recordation. All easements are for surface and underground drainage and for underground utilities, unless noted otherwise. All unrestricted easements are subject to the right of the City of Richmond, Virginia to establish alleys on said easements at a future time without cost of the property involved. The dedication of easements to the City includes the right to make reasonable use of the adjoining land for construction and maintenance of public facilities within the boundaries of the easements shown hereon. All dedications of land are subject to the right of the City of Richmond, Virginia to establish streets, alleys, or easements on such property at a future time without cost of the property involved.

IN WITNESS WHEREOF, the Owners have affixed their signature and seal as of this \_\_\_\_\_ day of \_\_\_\_\_, 20\_\_  
By: \_\_\_\_\_  
Owner

COMMONWEALTH OF VIRGINIA  
CITY/COUNTY OF \_\_\_\_\_, To-wit:

I, \_\_\_\_\_, a Notary Public in and for the jurisdiction aforesaid, do hereby certify that \_\_\_\_\_, who is known to me and whose name is signed to the foregoing instrument personally appeared before me and has acknowledged the same before me in the jurisdiction aforesaid this \_\_\_\_\_ day of \_\_\_\_\_, 20\_\_.

Notary Public  
My commission expires: \_\_\_\_\_ (SEAL)  
Registration No.: \_\_\_\_\_

## SOURCE OF TITLE

The property embraced within the limits of this subdivision is that property conveyed to THE CITY OF RICHMOND:

1. from Louisa A. Bose, et al by deed dated the 7th day of March 1918 and recorded at the Clerk's office in the Circuit Court of the City of Richmond, Division I, Virginia on the 24th day of June 1918 in Book 250A on Page 122, LESS and EXCEPT the following: (1) Parcel 1 as described therein and (2) all that portion of Parcel 2 lying south of the stream currently in use by Oakwood Cemetery.
2. And from Conrad Jacob Feitig, et al, by Petition and Order dated the 8th day of April 1946 and recorded at the Clerk's office in the Circuit Court of the City of Richmond, Virginia on the 7th day of August 1946 in Book 484B on Page 490. See Department of Public Works Drawing Number O-11943, dated the 19th of March, 1954 for subsequent agreed upon property line changes.

The property embraced within the limits of this subdivision is not subject to a Deed of Trust or Mortgage.

## SURVEYOR'S CERTIFICATE

To the best of my knowledge and belief all of the requirements as set forth in the ordinance for approving of plats of subdivision in the City of Richmond, Virginia have been complied with. All monuments have been previously set or will be set by the \_\_\_\_\_ day of \_\_\_\_\_, 20\_\_.  
(Not to exceed one year from recordation.)

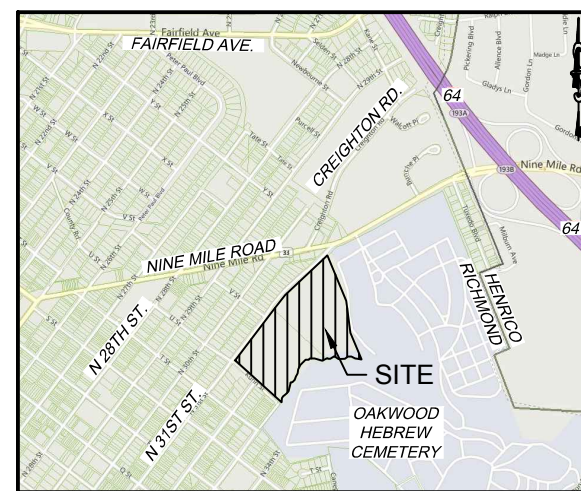

VICINITY MAP  
(SCALE 1" = 2000')

## CUP DEVELOPMENT STANDARDS

Single-Family	Minimum Lot		Setbacks (ft)				Max Lot Coverage
	Area (sf)	Width (ft)	Front (min)	Front (max)	Side	Rear	
Detached	3,200	32	10	20	6	5	55%
Attached	1,600	16 (22 if end)	10	20	3*	5	55%
Multifamily	Unit Area (sf)	Building Width (ft)	Setbacks (ft)				Other
			Front (min)	Front (max)	Side	Rear	
Apartment Buildings	600	N/A	10	N/A	7	7	FAR < 1.2 12' between bldgs.* 12' between bldgs.*
Stacked Flats	600	16	10	20	6*	5	
Townhouses	950	16	10	20	6*	5	
Non-Dwelling Use	Minimum Lot		Setbacks (ft)				
	Area (sf)	Width (ft)	Front (min)	Front (max)	Side	Rear	
Principal Uses	N/A	N/A	10	N/A	12	20	

\*Unless Attached



CITY OF RICHMOND APPROVAL

## NOTES

1. Use: Single Family Attached and Detached Residential / Multi-family Residential / Community Building and spaces
2. Zoning: By CUP Ordinance No. 2015-5-30 (Base Zoning R-5)
3. Setbacks: See Development Standards table.
4. Address: 1611 N. 31st Street, Richmond, VA 23223-5404
5. Tax map reference number: E0003312006 and E0003312005
6. Water: Public - City of Richmond, Virginia
7. Sewer: Public - City of Richmond, Virginia
8. Drainage: Curb & Gutter
9. Public Utilities: Underground (New) / Overhead (Existing)
10. Owner: City of Richmond
11. Developer: Church Hill North Phase I, LLC
12. Total Area: 21.76 Acres (948,080 SF)  
Area in Roads: 5.89 Acres (256,414 SF)  
Area in Lots: 10.36 Acres (451,137 SF)  
Area of Land Dedicated for Common Purposes: 5.52 Acres (240,529 SF)
13. Number of Lots: 82 Total  
7 Common Area Lots  
75 Residential Lots (50 Single-Family)  
Minimum Lot size: 1,616 SF  
Maximum Lot size: 30,036 SF  
Average Lot size: 6,015 SF
14. Dwelling Units: 264 Total
15. Property within the limits of this subdivision is located in Zone X, areas determined to be outside the 0.2% annual chance floodplain, as shown on the FEMA Flood Insurance Rate Map Number 5101290042D for the City of Richmond, dated April 2, 2009.
16. Property within the limits of this subdivision contains wetlands. A wetland delineation was performed and GPS located on September 22, 2014 by Timmons Group. Flags were later field located by H&B Surveying and Mapping, LLC. The location is shown on the plans. The designated wetlands do not extend beyond the tops of banks of the creek.
17. Property within the limits of this subdivision is located in Chesapeake Bay Preservation Areas designated by the City of Richmond, Virginia pursuant to Chapter 50 of the City Code of 2004. A perennial stream determination was performed in June of 2008 by Timmons Group. The wetland delineation was used in conjunction with the stream determination to determine the limits of the Resource Protection Area which is denoted on the plans.

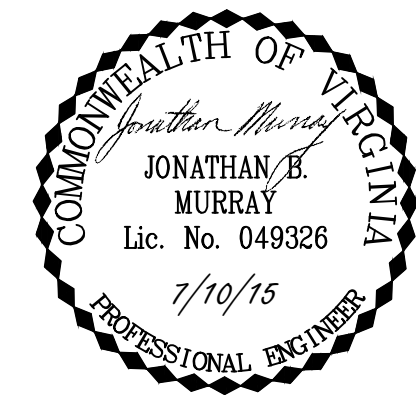

PRELIMINARY PLAT OF  
CHURCH HILL NORTH  
SUBDIVISION

7th District	City of Richmond, VA
Date: July 10, 2015	Scale: 1"=100'
Sheet 1 of 6	J.N.: 35794
Drawn by: J. MURRAY	Checked by: I. WU
Revised:	

S:\40135794-Church\_Hill\_North\_Re\DWG\Sheet\Phase 1 - Preliminary Plat\35794-PRELIM PLAT-2 OF 6.dwg | Plotted on 7/10/2015 9:08 AM | by Andrew Campbell

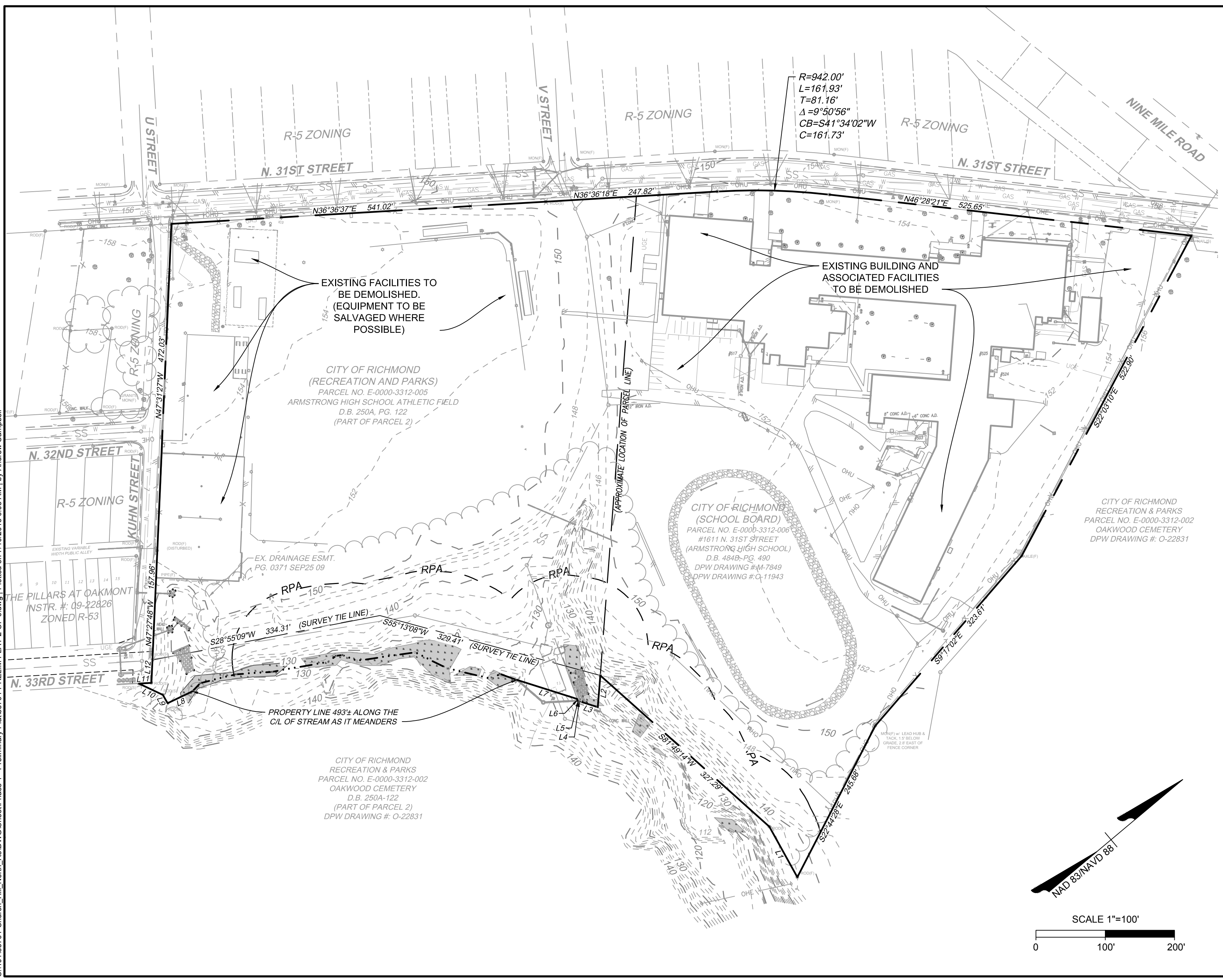

LINE TABLE		
LINE	BEARING	LENGTH
L1	N78°58'34"W	83.16'
L2	S45°30'54"E	45.92'
L3	S57°27'42"W	26.12'
L4	S63°22'09"W	3.31'
L5	S37°27'02"W	0.90'
L6	N70°35'38"W	3.00'
L7	S57°34'46"W	91.01'
L8	S14°29'07"W	39.65'
L9	N79°25'10"W	13.81'
L10	S65°16'21"W	38.21'
L11	N36°39'44"E	18.05'
L12	N47°27'48"W	32.90'

CITY OF RICHMOND APPROVAL

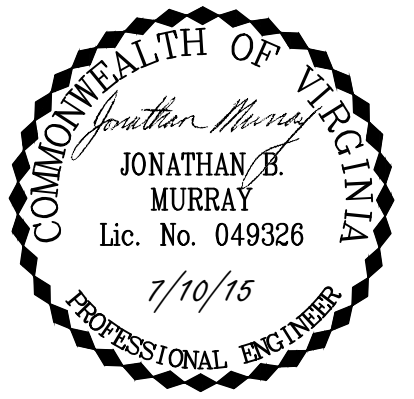

PRELIMINARY PLAT OF  
**CHURCH HILL NORTH  
 SUBDIVISION**

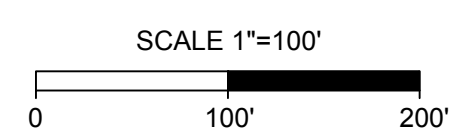

7th District	City of Richmond, VA
Date: July 10, 2015	Scale: 1"=100'
Sheet 2 of 6	J.N.: 35794
Drawn by: J. MURRAY	Checked by: I. WU
Revised:	

THIS DRAWING PREPARED AT THE  
**CORPORATE OFFICE**  
 1001 Boulders Parkway, Suite 300 | Richmond, VA 23225  
 TEL 804.200.6500 FAX 804.560.1016 www.timmons.com  
 YOUR VISION. ACHIEVED THROUGH OURS.  
**TIMMONS GROUP**

S:\40135794-Church Hill\_North\_ReDWG\Sheet\Phase 1 - Preliminary Plat\35794-PRELIM PLAT-3 OF 6.dwg | Plotted on 7/13/2015 4:05 PM | by Andrew Campbell

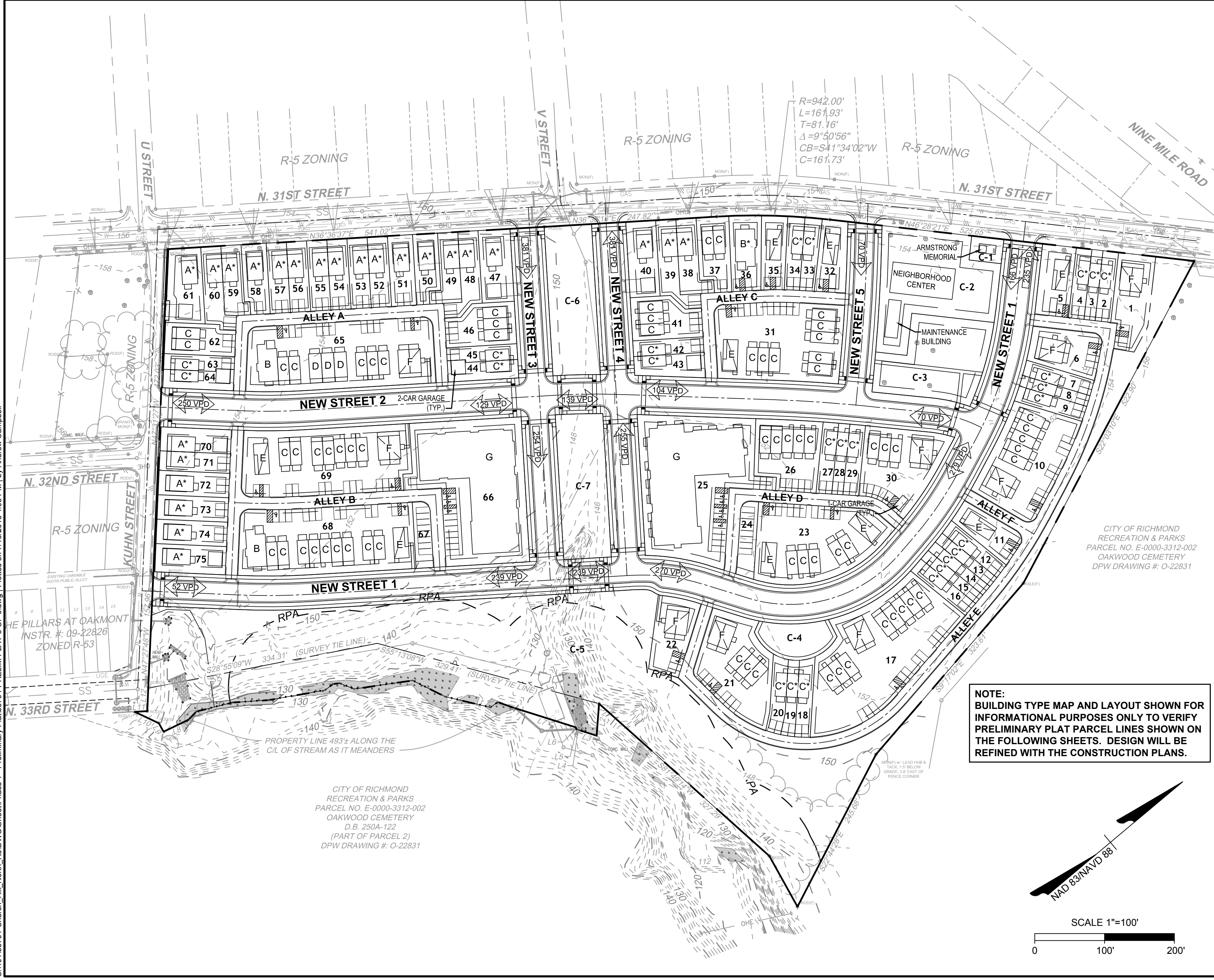

BUILDING TYPE KEY	
	<b>A.) ATTACHED OR DETACHED HOME</b> 22' x 34' 1 DWELLING UNIT (24 TOTAL D.U.)
	<b>B.) BUNGALOW</b> 28' x 54' 1 DWELLING UNIT (3 TOTAL D.U.)
	<b>C.) TOWNHOUSE</b> 16' x 34' 1 DWELLING UNIT (93 TOTAL D.U.)
	<b>D.) LARGE TOWNHOUSE</b> 18' x 36' 1 DWELLING UNIT (3 TOTAL D.U.)
	<b>E.) STACKED FLAT</b> 21' x 44' 2 DWELLING UNITS (18 TOTAL D.U.)
	<b>F.) STACKED TOWN</b> 32' x 34' 3 DWELLING UNITS (27 TOTAL D.U.)
	<b>G.) APARTMENT BUILDING</b> APPROX. 140' x 170' 48 DWELLING UNITS (96 TOTAL D.U.)
<b>264 TOTAL DWELLING UNITS PROPOSED</b>	
* ASTERISK INDICATES A SUBDIVIDED "SINGLE-FAMILY" LOT (50 TOTAL)	

**NOTE:**  
BUILDING TYPE MAP AND LAYOUT SHOWN FOR INFORMATIONAL PURPOSES ONLY TO VERIFY PRELIMINARY PLAT PARCEL LINES SHOWN ON THE FOLLOWING SHEETS. DESIGN WILL BE REFINED WITH THE CONSTRUCTION PLANS.

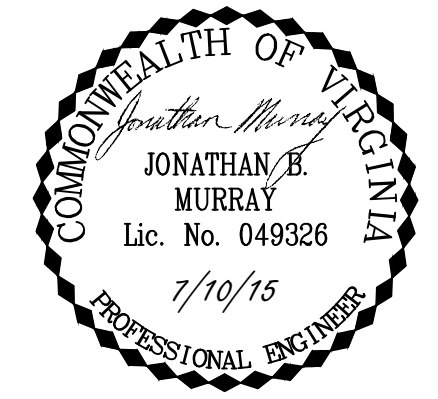
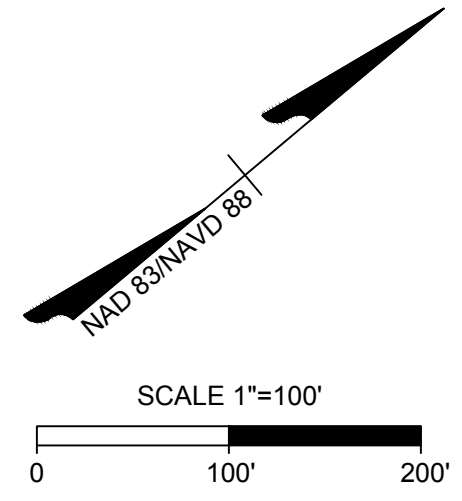

**PRELIMINARY PLAT OF  
CHURCH HILL NORTH  
SUBDIVISION**

7th District	City of Richmond, VA
Date: July 10, 2015	Scale: 1"=100'
Sheet 3 of 6	J.N.: 35794
Drawn by: J. MURRAY	Checked by: I. WU
Revised:	

THIS DRAWING PREPARED AT THE  
**CORPORATE OFFICE**  
1001 Boulder Parkway, Suite 300 | Richmond, VA 23225  
TEL: 804.200.6500 FAX: 804.560.1016 www.timmons.com

YOUR VISION. ACHIEVED THROUGH OURS.

**TIMMONS GROUP**

S:\40135794-Church Hill\_North\_Re\DWG\SheetPhase 1 - Preliminary Plat\35794-PRELIM PLAT-4 OF 6.dwg | Plotted on 7/10/2015 9:08 AM | By Andrew Campbell

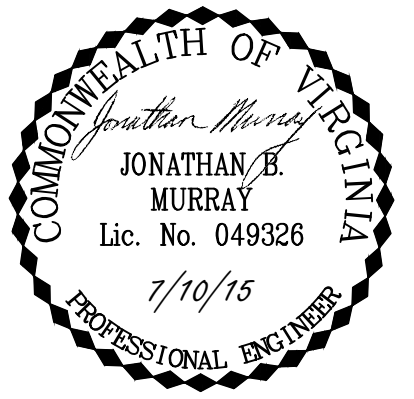
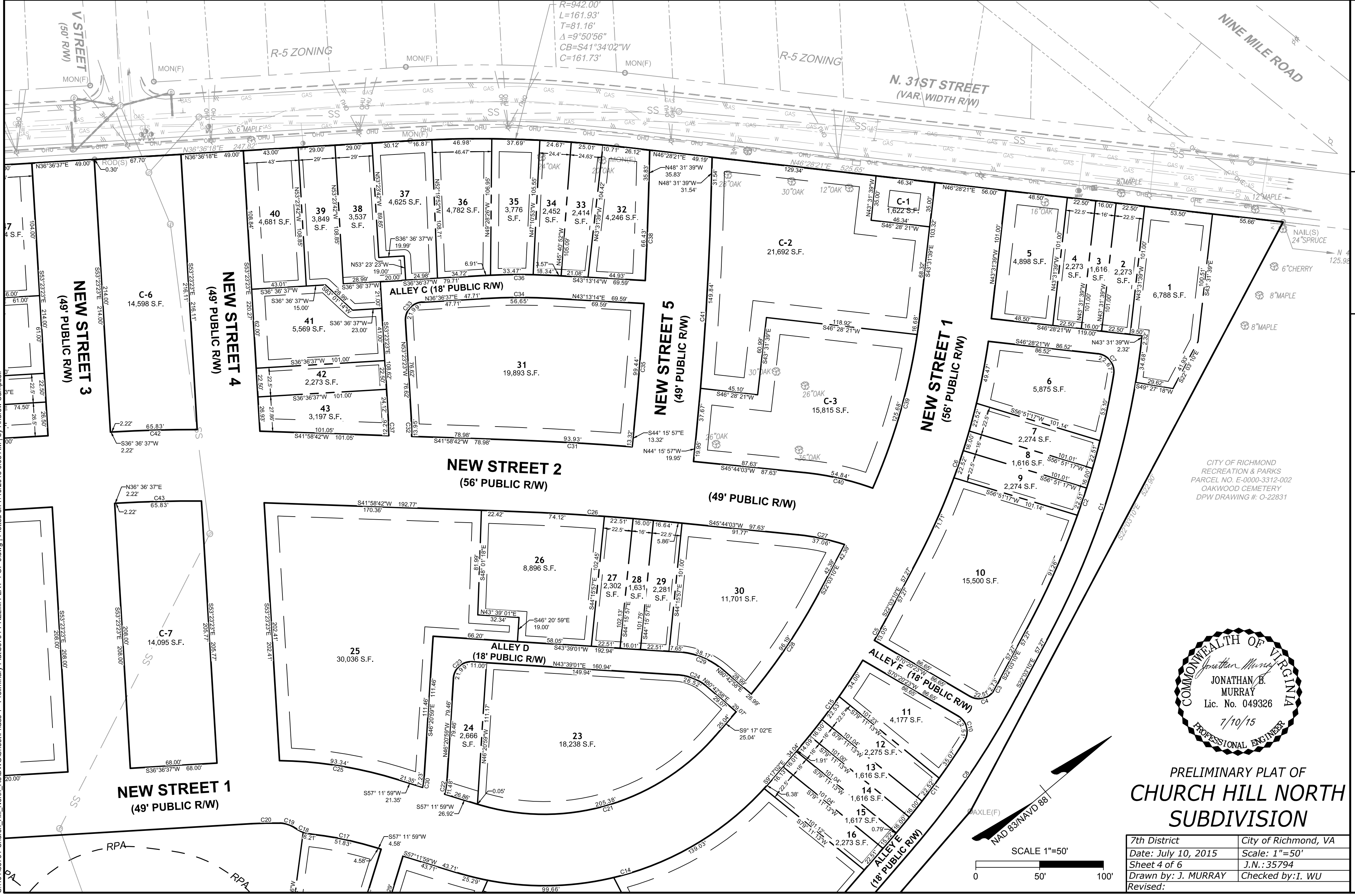

**PRELIMINARY PLAT OF  
CHURCH HILL NORTH  
SUBDIVISION**

7th District	City of Richmond, VA
Date: July 10, 2015	Scale: 1"=50'
Sheet 4 of 6	J.N.: 35794
Drawn by: J. MURRAY	Checked by: I. WU
Revised:	

THIS DRAWING PREPARED AT THE  
**CORPORATE OFFICE**  
1001 Boulders Parkway, Suite 300 | Richmond, VA 23225  
TEL: 804.200.6500 FAX: 804.560.1016 www.timmons.com

YOUR VISION ACHIEVED THROUGH OURS.

**TIMMONS GROUP**

S:\40135794-Church\_Hill\_North\_Re\DWG\Sheet\Phase 1 - Preliminary Plat\35794-PRELIM PLAT-4 OF 6.dwg | Plotted on 7/10/2015 9:09 AM | by Andrew Campbell

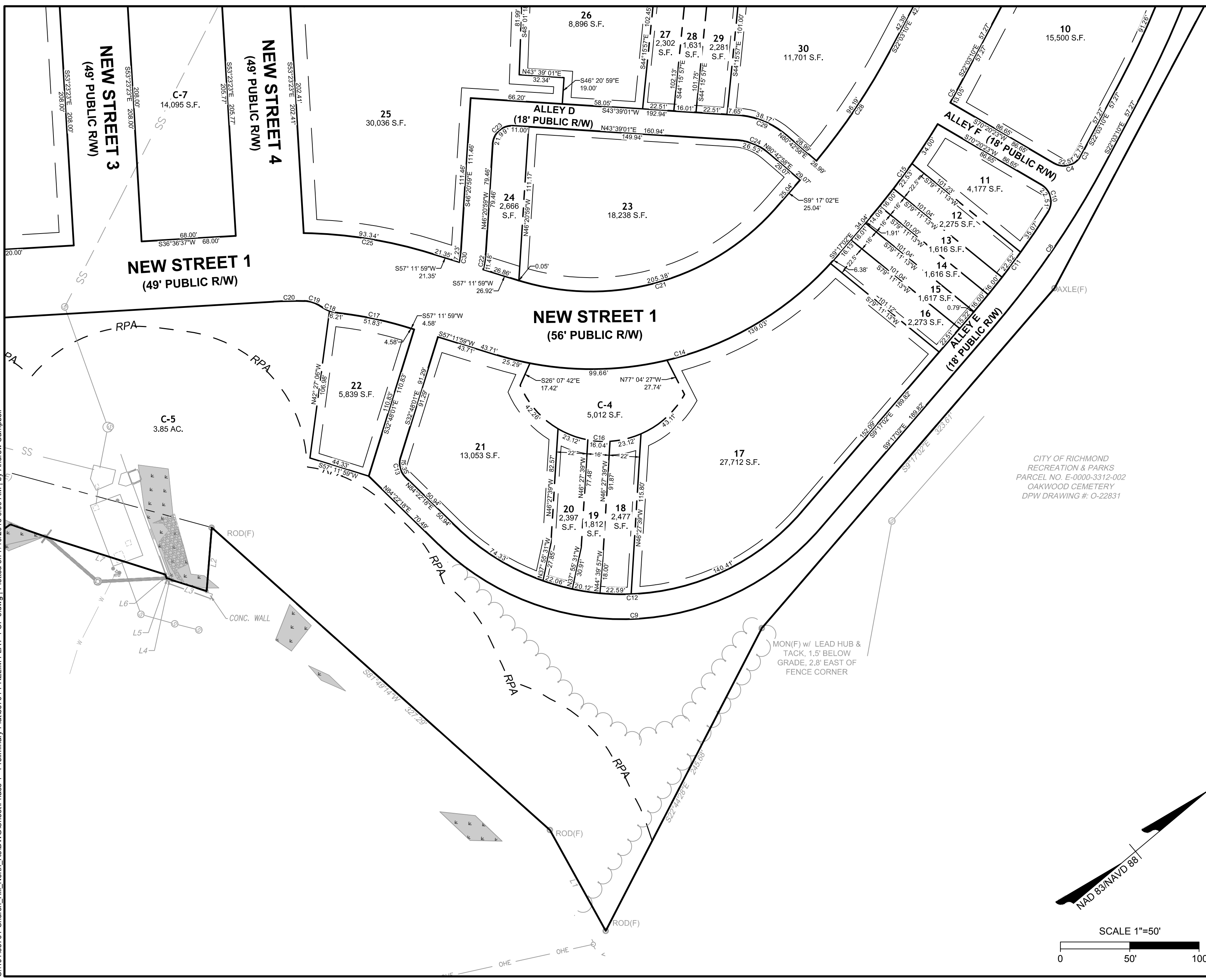

CITY OF RICHMOND  
RECREATION & PARKS  
PARCEL NO. E-0000-3312-002  
OAKWOOD CEMETERY  
DPW DRAWING #: O-22831

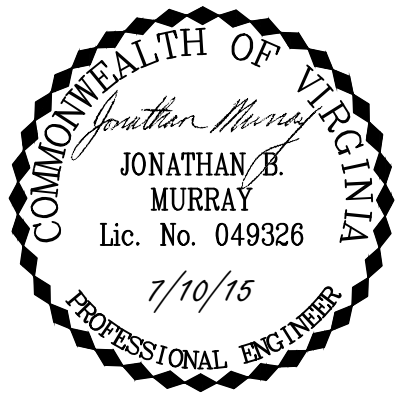

PRELIMINARY PLAT OF  
**CHURCH HILL NORTH  
SUBDIVISION**

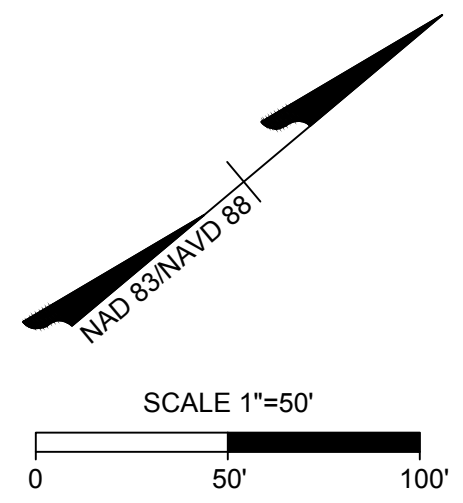

7th District	City of Richmond, VA
Date: July 10, 2015	Scale: 1"=50'
Sheet 5 of 6	J.N.: 35794
Drawn by: J. MURRAY	Checked by: I. WU
Revised:	

**TIMMONS GROUP**

YOUR VISION ACHIEVED THROUGH OURS.  
THIS DRAWING PREPARED AT THE  
CORPORATE OFFICE  
1001 Boulders Parkway, Suite 300 | Richmond, VA 23225  
TEL 804.200.6500 FAX 804.560.1016 www.timmons.com

S:\40135794-Church Hill North ReDWG\SheetPhase 1 - Preliminary Plat\35794-PRELIM PLAT-4 OF 6.dwg | Plotted on 7/10/2015 9:09 AM | by Andrew Campbell

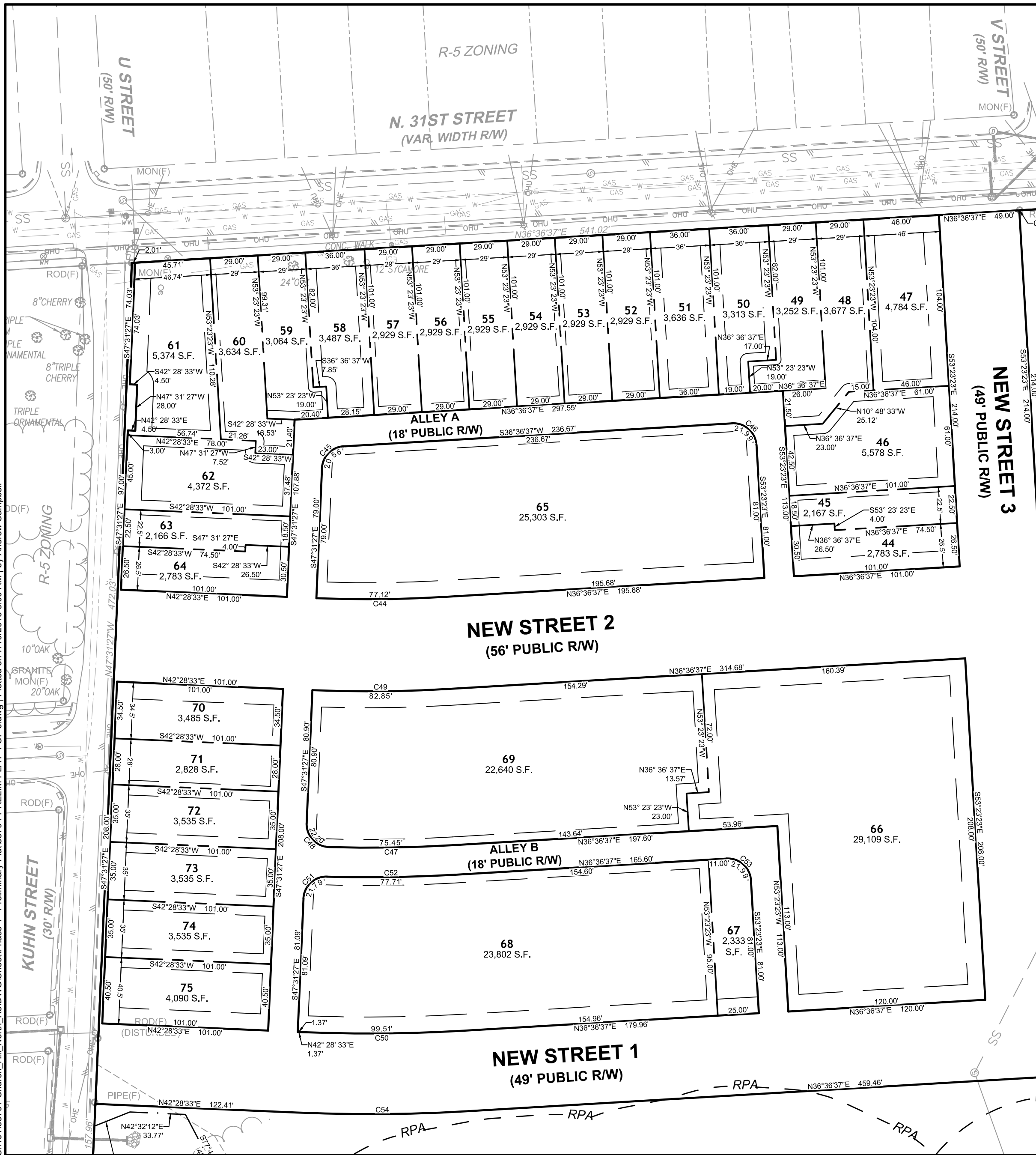

SEE INSET DETAIL

CURVE TABLE						
CURVE	RADIUS	LENGTH	TANGENT	DELTA	CHORD BEARING	CHORD
C1	647.00	242.50	122.69	21°28'29"	N32°47'25"W	241.08
C2	629.00	205.38	103.61	18°42'31"	N31°24'25"W	204.47
C3	629.00	2.73	1.37	0°14'57"	N21°55'42"W	2.73
C4	14.00	22.51	14.53	92°08'36"	N24°16'05"E	20.17
C5	528.00	13.05	6.52	1°24'56"	S21°20'42"E	13.05
C6	528.00	182.21	92.02	19°46'22"	S31°56'21"E	181.31
C7	14.00	22.67	14.69	92°45'59"	N87°08'40"W	20.27
C8	647.00	144.19	72.40	12°46'08"	N15°40'06"W	143.89
C9	189.00	308.94	201.46	93°39'19"	N37°32'38"E	275.68
C10	14.00	22.51	14.53	92°08'36"	N63°35'20"W	20.17
C11	629.00	90.39	45.27	8°14'00"	N13°24'02"W	90.31
C12	171.00	279.52	182.27	93°39'19"	N37°32'38"E	249.42
C13	14.00	15.35	8.55	62°49'41"	S64°12'52"E	14.59
C14	233.00	270.36	152.71	66°29'01"	S23°57'29"W	255.45
C15	528.00	86.62	43.41	9°24'00"	S13°59'02"E	86.53
C16	66.00	147.65	135.86	128°10'49"	S43°10'23"W	118.73
C17	272.00	51.83	25.99	10°55'02"	S51°44'28"W	51.75
C18	26.00	13.26	6.78	29°12'50"	S60°53'21"W	13.11
C19	21.00	12.58	6.48	34°18'53"	S58°20'20"W	12.39
C20	279.00	22.26	11.14	4°34'16"	S38°53'45"W	22.25
C21	177.00	205.38	116.01	66°29'01"	S23°57'29"W	194.05
C22	59.00	11.48	5.76	11°09'06"	N40°46'27"W	11.47
C23	14.00	21.99	14.00	90°00'00"	S1°20'59"E	19.80
C24	41.00	26.52	13.74	37°03'58"	N62°10'59"E	26.06
C25	328.00	93.34	46.99	16°18'20"	S49°02'49"W	93.03
C26	1972.00	129.27	64.66	3°45'21"	S43°51'22"W	129.24
C27	172.00	37.06	18.60	12°20'41"	S51°54'23"W	36.99
C28	472.00	96.19	48.26	11°40'35"	S16°12'52"E	96.02
C29	59.00	38.17	19.78	37°03'58"	N62°10'59"E	37.51
C30	41.00	7.23	3.62	10°05'52"	S41°18'04"E	7.22
C31	2028.00	93.93	46.98	2°39'14"	S43°18'19"W	93.93
C32	209.00	13.95	6.98	3°49'27"	N51°28'39"W	13.95
C33	14.00	21.99	14.00	90°00'00"	N8°23'23"W	19.80
C34	491.00	56.65	28.36	6°36'37"	N39°54'56"E	56.62
C35	2472.00	99.44	49.73	2°18'17"	S45°25'06"E	99.44
C36	509.00	58.72	29.39	6°36'37"	S39°54'56"W	58.69
C37	191.00	12.26	6.13	3°40'43"	S51°33'01"E	12.26
C38	2472.00	66.43	33.22	1°32'23"	N47°45'28"W	66.42
C39	472.00	142.37	71.73	17°16'55"	S34°53'12"E	141.83
C40	221.00	54.84	27.56	14°13'02"	S52°50'34"W	54.70
C41	2521.00	187.51	93.80	4°15'42"	N46°23'48"W	187.47
C42	1028.00	65.83	32.93	3°40'08"	S38°26'41"W	65.82
C43	972.00	65.83	32.93	3°52'50"	N38°33'02"E	65.82
C44	772.00	77.12	38.59	5°43'26"	N39°28'20"E	77.09
C45	14.00	20.56	12.64	84°08'04"	S5°27'25"E	18.76
C46	14.00	21.99	14.00	90°00'00"	S81°36'37"W	19.80
C47	866.00	75.45	37.75	4°59'31"	N39°06'23"E	75.43
C48	14.00	22.20	14.22	90°52'25"	N87°02'21"E	19.95
C49	828.00	82.85	41.46	5°44'00"	N39°28'37"E	82.82
C50	972.00	99.51	49.80	5°51'56"	N39°32'35"E	99.46
C51	14.00	21.79	13.80	89°10'16"	S2°56'19"E	19.66
C52	884.00	77.71	38.88	5°02'12"	N39°07'43"E	77.69
C53	14.00	21.99	14.00	90°00'00"	S81°36'37"W	19.80
C54	1021.00	104.52	52.31	5°51'56"	N39°32'35"E	104.48

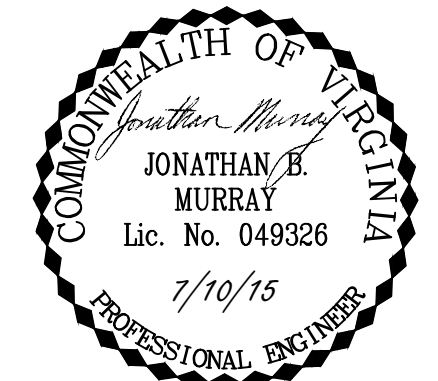
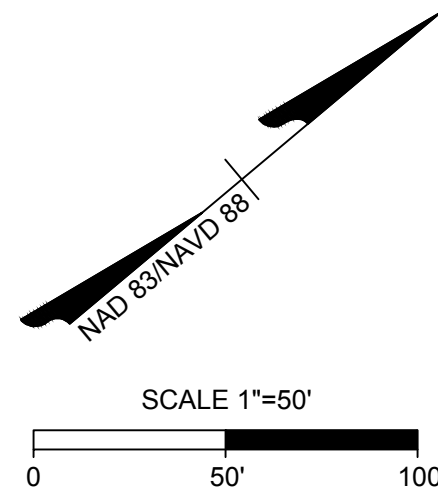
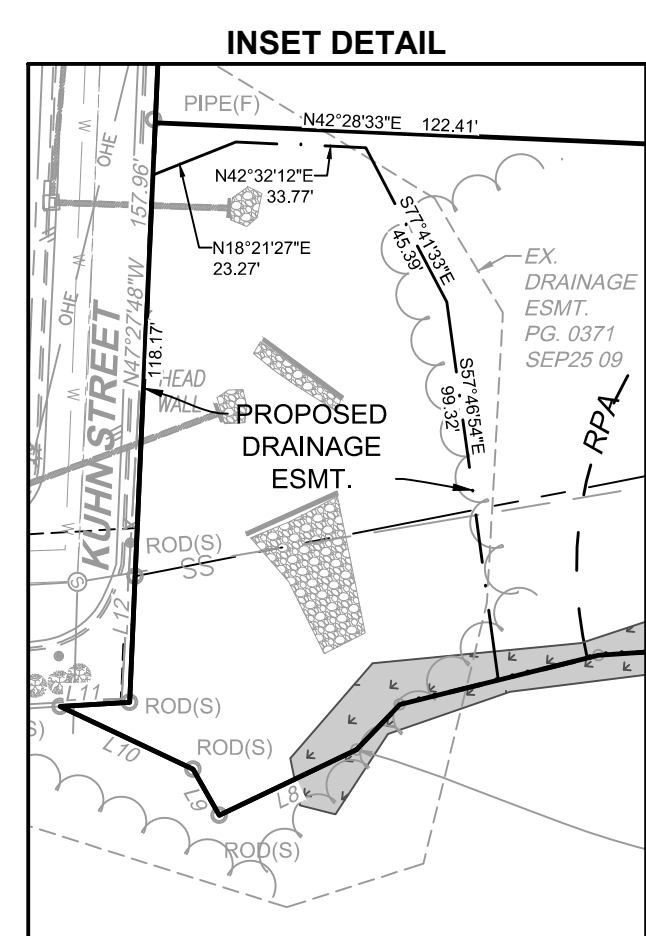

PRELIMINARY PLAT OF  
**CHURCH HILL NORTH**  
**SUBDIVISION**

7th District	City of Richmond, VA
Date: July 10, 2015	Scale: 1"=50'
Sheet 6 of 6	J.N.: 35794
Drawn by: J. MURRAY	Checked by: I. WU
Revised:	

THIS DRAWING PREPARED AT THE  
**CORPORATE OFFICE**  
 1001 Boulder Parkway, Suite 300 | Richmond, VA 23225  
 TEL 804.200.6500 FAX 804.560.1016 www.timmons.com

YOUR VISION ACHIEVED THROUGH OURS.

**TIMMONS GROUP**